







Rigid Conduit Fittings for Ex d/e applications

E-CARINA



Technical Details		
Material	Body	Brass, Brass Nickel Plated, Stainless Steel 316L, Aluminium
	Seal	CR (Chloroprene), Silicone
	O-ring	CR (Chloroprene), Silicone
Ingress Protection Rating	IP 68 - 5 Bar, 30 min IP 66	
Operating Temperature	Seal Material	
	CR (Chloroprene)	Silicone
Ex d/tb	-40°C to +80°C	-60°C to +80°C
Ex e/tb	-40°C to +80°C	-60°C to +140°C
Equipment For	Gas & Dust potentially explosive atmospheres	
Suitable for use in	Group II	Gas Group IIC ZONE1/ZONE2
	Group III	Dust Group IIIC ZONE21/ZONE 22
Equipment Marking	Ex II 2GD Ex db IIC Gb Ex eb IIC Gb Ex tb IIIC Db	
Marking Example *	BMD EBM.. CE 0722  II 2GD Ex db IIC Gb Ex eb IIC Gb Ex tb IIIC Db Ta -40°C to +80°C IP66/68 IMQ 13 ATEX 018X IECEx IMQ 13.0006X	
Thread Type	<ul style="list-style-type: none"> • Metric (M) ISO Pitch 1,5 • NPT (N) ANSI ASME B1.20.1 • Other thread types also available upon request. 	
Cable Type	Non Armoured	
Accessories	<ul style="list-style-type: none"> • Lock nuts • Gaskets (Washers) • Serrated Washers • Earth tags 	
Remarks	<ul style="list-style-type: none"> • Accessories must be ordered separately. • O-ring only available when male thread is Metric. 	
Approvals	Certificate Number	Standards
	IMQ 13 ATEX 018X	EN 60079-0:2012+A11:2013 EN 60079-7:2015 EN 60079-31:2014 EN 60079-1:2014
	IECEx IMQ 13.0006X	IEC 60079-0:2011 Edition:6 IEC 60079-7:2015 Edition:5 IEC 60079-31:2013 Edition:2 IEC 60079-1:2014 Edition:7
	№ TC RU C-TR.AA87.B.00941	ГОСТ 31610.0-2014 ГОСТ IEC 60079-1:2013 ГОСТ IEC 60079-31:2013
	DNV 12.0052 X	ABNT NBR IEC 60079-0:2013 ABNT NBR IEC 60079-1:2009 ABNT NBR IEC 60079-7:2008 ABNT NBR IEC 60079-31:2011
	E-14044	IEC/EN60079-0 IEC/EN60079-7 IEC/EN60079-31 IEC/EN60079-1 IEC/EN 62444

-For more information see our webpage.
* The standard marking consists ATEX & IECEx only. Marking acc. to other standards on request.



Order Coding								
Part Number	Material	Seal	-	Gasket (Washer)	Serrated Washer	Lock Nut	Earth Tag	for Ex e
Mandatory	Mandatory	Mandatory	-	Option	Option	Option	Option	Option
See table	B Brass BN Brass Nickel plated X Stainless steel 316L A Aluminium	C Chloroprene S Silicone	-	WC Chloroprene WS Silicone WF Fiber	WSR Serrated washer	L Lock nut	E Earth tag	TL9
Example								
EBMOSMOSN	BN	S	-	WC	WSR	L	E	TL9

E-CARINA

Rigid Conduit Fittings for Ex d/e applications

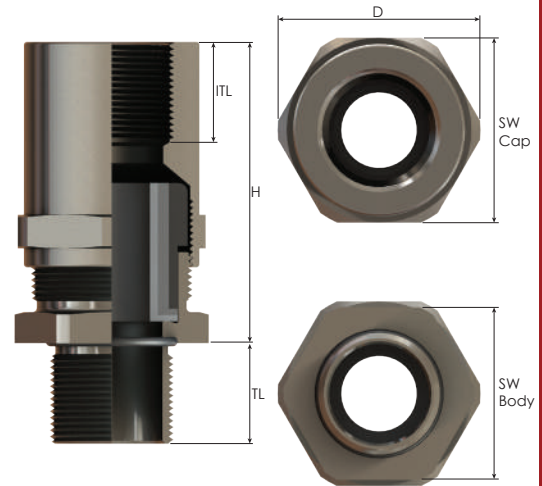

Thread Type **METRIC** acc. to ISO 965-3







Outer Thread Size (Male)	Inner Thread Size (Female)	Clamping Range		Outer Thread Length		Inner Thread Length	Spanner Width		Outer Ø	max. Height	Part Number
		Ø min-max mm	Seal Type	Ex-e min.	Ex-d/e min.		Cap	Body			
				TL m	ITL mm	SW Cap mm	SW Body mm	D mm	H mm		
M12x1,5	NPT 1/4"	4,0 - 8,0	Triple	9,0	16,0	24	22	26,5	49,5	EBM0SM0SN*	
	NPT 3/8"	4,0 - 8,0	Triple	9,0	16,0	24	22	26,5	49,5	EBM0SM01N*	
M16x1,5	NPT 1/4"	4,0 - 8,0	Triple	9,0	16,0	24	22	26,5	49,5	EBM01M0SN	
	NPT 3/8"	4,0 - 12,0	Triple	9,0	16,0	24	22	26,5	49,5	EBM01M01N	
	NPT 1/2"	4,0 - 12,0	Triple	9,0	16,0	24	22	26,5	49,5	EBM01M12N	
M20x1,5	NPT 3/8"	4,0 - 12,0	Triple	9,0	16,0	24	22	26,5	46,0	EBM12M01N	
	NPT 1/2"	4,0 - 12,0	Triple	9,0	16,0	24	22	26,5	46,0	EBM1M1N	
	NPT 1/2"	10,0 - 16,0	Triple	9,0	16,0	30	28	33,0	49,0	EBM12M12N	
	NPT 3/4"	10,0 - 16,0	Triple	9,0	16,0	30	28	33,0	49,0	EBM12M23N	
M25x1,5	NPT 1/2"	10,0 - 16,0	Triple	9,0	16,0	30	28	33,0	49,5	EBM23M12N	
	NPT 3/4"	10,0 - 18,0	Triple	9,0	16,0	30	28	33,0	49,5	EBM2M2N	
	NPT 3/4"	14,0 - 20,0	Triple	9,0	16,0	35	35	39,0	54,0	EBM23M23N	
	NPT 1"	14,0 - 20,0	Triple	9,0	16,0	35	35	39,0	57,0	EBM23M34N	
M32x1,5	NPT 3/4"	14,0 - 20,0	Triple	9,0	16,0	35	35	39,0	52,0	EBM34M23N	
	NPT 1"	14,0 - 24,0	Triple	9,0	16,0	35	35	39,0	56,0	EBM3M3N	
	NPT 1"	22,0 - 26,0	Triple	9,0	16,0	45	45	50,0	67,5	EBM34M34N	
	NPT 1 1/4"	22,0 - 28,0	Triple	9,0	16,0	50	45	55,5	65,5	EBM34M45N	
M40x1,5	NPT 1"	22,0 - 26,0	Triple	9,0	18,0	45	45	50,0	67,5	EBM45M34N	
	NPT 1 1/4"	22,0 - 32,0	Triple	9,0	18,0	50	45	55,0	65,5	EBM4M4N	
	NPT 1 1/4"	26,0 - 34,0	Triple	9,0	18,0	50	50	56,0	68,0	EBM45M45N	
	NPT 1 1/2"	26,0 - 34,0	Triple	9,0	18,0	50	50	56,0	69,0	EBM45M56N	
M50x1,5	NPT 1 1/4"	26,0 - 34,0	Triple	9,0	18,0	50	55	61,0	68,0	EBM5M45N	
	NPT 1 1/2"	26,0 - 35,0	Triple	9,0	18,0	55	55	61,0	69,0	EBM5M5N	
	NPT 1 1/2"	35,0 - 41,0	Triple	9,0	18,0	64	64	70,0	66,5	EBM56M56N	
	NPT 2"	35,0 - 44,0	Triple	9,0	18,0	68	64	75,0	69,5	EBM56M67N	
M63x1,5	NPT 1 1/2"	35,0 - 41,0	Triple	9,0	18,0	64	68	75,0	69,0	EBM67M56N	
	NPT 2"	35,0 - 45,0	Triple	9,0	18,0	68	68	75,0	69,0	EBM6M6N	
	NPT 2"	46,0 - 52,0	Triple	9,0	18,0	80	75	89,0	72,0	EBM67M67N	
	NPT 2 1/2"	46,0 - 56,0	Triple	9,0	18,0	80	75	89,0	76,0	EBM67M78N	
M75x1,5	NPT 2 1/2"	46,0 - 62,0	Triple	9,0	20,0	80	80	89,0	73,0	EBM7M7N	
	NPT 2 1/2"	60,0 - 64,0	Triple	9,0	20,0	95	95	105,0	76,0	EBM78M78N	
	NPT 3"	60,0 - 69,0	Triple	9,0	20,0	95	95	105,0	76,0	EBM78M810N	
M90x1,5	NPT 2 1/2"	60,0 - 64,0	Triple	9,0	20,0	105	95	117,0	76,0	EBM810M78N	
	NPT 3"	60,0 - 75,0	Triple	9,0	20,0	95	95	105,0	76,0	EBM8M8N	
	NPT 3"	75,0 - 79,5	Triple	9,0	20,0	105	105	117,0	76,0	EBM810M810N	
	NPT 4"	75,0 - 82,0	Triple	9,0	20,0	105	105	117,0	76,0	EBM810M10N	
M100x1,5	NPT 3"	75,0 - 79,5	Triple	9,0	20,0	105	105	117,0	76,0	EBM10M810N	
	NPT 4"	75,0 - 85,0	Triple	9,0	20,0	105	105	117,0	76,0	EBM10M10N	
M110x1,5	NPT 4"	85,0 - 95,0	Triple	9,0	20,0	115	115	128,0	77,0	EBM11M11N	

* Only Ex e/ Ex tb execution.

Rigid Conduit Fittings for Ex d/e applications

E-CARINA



Technical Details	
Material	Body Brass, Brass Nickel Plated, Stainless Steel 316L, Aluminium Seal CR (Chloroprene), Silicone O-ring CR (Chloroprene), Silicone
Ingress Protection Rating	IP 68 - 5 Bar, 30 min IP 66
Operating Temperature	Seal Material CR (Chloroprene) -40°C to +80°C Silicone -60°C to +80°C
Equipment For	Gas & Dust potentially explosive atmospheres
Suitable for use in	Group II Gas Group IIC ZONE1/ZONE2 Group III Dust Group IIIC ZONE21/ZONE 22
Equipment Marking	Ex II 2GD Ex db IIC Gb Ex eb IIC Gb Ex tb IIIC Db
Marking Example *	BMD EBM.. CE 0722  II 2GD Ex db IIC Gb Ex eb IIC Gb Ex tb IIIC Db Ta -40°C to +80°C IP66/68 IMQ 13 ATEX 018X IECEx IMQ 13.0006X
Thread Type	<ul style="list-style-type: none"> • Metric (M) ISO Pitch 1,5 • NPT (N) ANSI ASME B1.20.1 • Other thread types also available upon request.
Cable Type	Non Armoured
Accessories	<ul style="list-style-type: none"> • Lock nuts • Gaskets (Washers) • Serrated Washers • Earth tags
Remarks	<ul style="list-style-type: none"> • Accessories must be ordered separately. • O-ring only available when male thread is Metric.
Approvals	Certificate Number Standards
	IMQ 13 ATEX 018X EN 60079-0:2012+A11:2013 EN 60079-7:2015 EN 60079-31:2014 EN 60079-1:2014
	IECEx IMQ 13.0006X IEC 60079-0:2011 Edition:6 IEC 60079-7:2015 Edition:5 IEC 60079-31:2013 Edition:2 IEC 60079-1:2014 Edition:7
	№ TC RU C-TR.AA87.B.00941 ГОСТ 31610.0-2014 ГОСТ IEC 60079-1:2013 ГОСТ IEC 60079-31:2013
	DNV 12.0052 X ABNT NBR IEC 60079-0:2013 ABNT NBR IEC 60079-1:2009 ABNT NBR IEC 60079-7:2008 ABNT NBR IEC 60079-31:2011
	E-14044 IEC/EN60079-0 IEC/EN60079-7 IEC/EN60079-31 IEC/EN60079-1 IEC/EN 62444

-For more information see our webpage.

* The standard marking consists ATEX & IECEx only. Marking acc. to other standards on request.



Order Coding								
Part Number	Material	Seal	-	Gasket (Washer)	Serrated Washer	Lock Nut	Earth Tag	for Ex e
Mandatory	Mandatory	Mandatory	-	Option	Option	Option	Option	Option
See table	B Brass BN Brass Nickel plated X Stainless steel 316L A Aluminium	C Chloroprene S Silicone	-	WC Chloroprene WS Silicone WF Fiber	WSR Serrated washer	L Lock nut	E Earth tag	TL9
Example								
EBMOSMOSN	BN	S	-	WC	WSR	L	E	TL9

E-CARINA

Rigid Conduit Fittings for Ex d/e applications

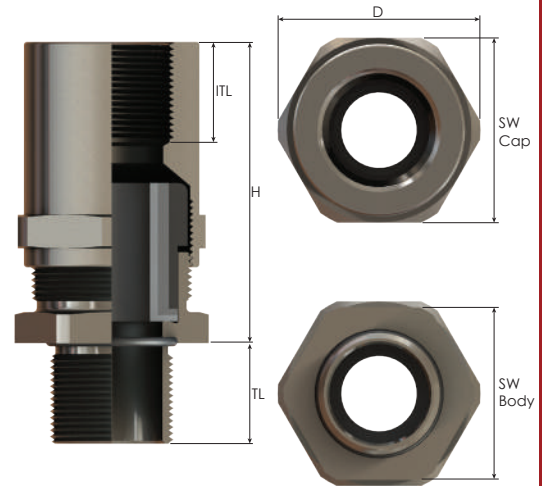

Thread Type **NPT** acc. to ANSI ASME B1.20.1

Outer Thread Size (Male)	Inner Thread Size (Female)	Clamping Range		Outer Thread Length	Inner Thread Length	Spanner Width		Outer Ø	max. Height		Part Number
		Ø min-max mm	Seal Type			SW Cap mm	SW Body mm		D mm	H mm	
NPT 1/4"	NPT 1/4"	4,0 - 8,0	Triple	16,0	16,0	24	22	26,5	49,5	EBM0S0N0SN*	
	NPT 3/8"	4,0 - 8,0	Triple	16,0	16,0	24	22	26,5	49,5	EBM0S0N01N*	
NPT 3/8"	NPT 1/4"	4,0 - 8,0	Triple	16,0	16,0	24	22	26,5	49,5	EBM01N0SN	
	NPT 3/8"	4,0 - 12,0	Triple	16,0	16,0	24	22	26,5	49,5	EBM01N01N	
	NPT 1/2"	4,0 - 12,0	Triple	16,0	16,0	24	22	26,5	49,5	EBM01N12N	
NPT 1/2"	NPT 3/8"	4,0 - 12,0	Triple	16,0	16,0	24	22	26,5	46,0	EBM12N01N	
	NPT 1/2"K	4,0 - 12,0	Triple	16,0	16,0	24	22	26,5	46,0	EBM1N1N	
	NPT 1/2"	10,0 - 16,0	Triple	16,0	16,0	30	28	33,0	49,0	EBM12N12N	
	NPT 3/4"	10,0 - 16,0	Triple	16,0	16,0	30	28	33,0	49,0	EBM12N23N	
NPT 3/4"	NPT 1/2"	10,0 - 16,0	Triple	16,0	16,0	30	28	33,0	49,0	EBM23N12N	
	NPT 3/4"K	10,0 - 18,0	Triple	16,0	16,0	30	28	33,0	49,0	EBM2N2N	
	NPT 3/4"	14,0 - 20,0	Triple	16,0	16,0	35	35	39,0	53,0	EBM23N23N	
	NPT 1"	14,0 - 20,0	Triple	16,0	20,0	35	35	39,0	57,0	EBM23N34N	
NPT 1"	NPT 3/4"	14,0 - 20,0	Triple	20,0	16,0	35	35	39,0	52,0	EBM34N23N	
	NPT 1"K	14,0 - 24,0	Triple	20,0	20,0	35	35	39,0	56,0	EBM3N3N	
	NPT 1"	22,0 - 26,0	Triple	20,0	20,0	45	45	50,0	67,0	EBM34N34N	
	NPT 1 1/4"	22,0 - 26,0	Triple	20,0	20,0	50	45	55,5	65,5	EBM34N45N	
NPT 1 1/4"	NPT 1"	22,0 - 26,0	Triple	20,0	20,0	45	45	50,0	67,5	EBM45N34N	
	NPT 1 1/4"K	22,0 - 32,0	Triple	20,0	20,0	50	45	55,5	65,5	EBM4N4N	
	NPT 1 1/4"	26,0 - 34,0	Triple	20,0	20,0	50	50	55,5	68,0	EBM45N45N	
	NPT 1 1/2"	26,0 - 34,0	Triple	20,0	20,0	50	50	55,5	69,0	EBM45N56N	
NPT 1 1/2"	NPT 1 1/4"	26,0 - 34,0	Triple	20,0	20,0	50	55	61,0	68,0	EBM5N45N	
	NPT 1 1/2"K	26,0 - 35,0	Triple	20,0	20,0	55	55	61,0	69,0	EBM5N5N	
	NPT 1 1/2"	35,0 - 41,0	Triple	20,0	20,0	64	64	70,0	66,0	EBM56N56N	
	NPT 2"	35,0 - 41,0	Triple	20,0	20,0	68	64	75,0	69,5	EBM56N67N	
NPT 2"	NPT 1 1/2"	35,0 - 41,0	Triple	20,0	20,0	64	68	75,0	69,5	EBM67N56N	
	NPT 2"K	35,0 - 45,0	Triple	20,0	20,0	68	68	75,0	69,5	EBM6N6N	
	NPT 2"	46,0 - 52,0	Triple	20,0	20,0	80	75	89,0	72,0	EBM67N67N	
	NPT 2 1/2"	46,0 - 52,0	Triple	20,0	21,0	80	75	89,0	76,0	EBM67N78N	
NPT 2 1/2"	NPT 2"	46,0 - 52,0	Triple	21,0	20,0	95	80	105,0	72,0	EBM78N67N	
	NPT 2 1/2"K	46,0 - 62,0	Triple	21,0	21,0	80	80	89,0	73,0	EBM7N7N	
	NPT 2 1/2"	60,0 - 64,0	Triple	21,0	21,0	95	95	105,0	76,0	EBM78N78N	
	NPT 3"	60,0 - 64,0	Triple	21,0	21,0	95	95	105,0	76,0	EBM78N810N	
NPT 3"	NPT 2 1/2"	60,0 - 64,0	Triple	21,0	21,0	105	95	117,0	76,0	EBM810N78N	
	NPT 3"K	60,0 - 75,0	Triple	21,0	21,0	95	95	105,0	76,0	EBM8N8N	
	NPT 3"	75,0 - 79,5	Triple	21,0	21,0	105	105	117,0	76,0	EBM810N810N	
	NPT 4"K	75,0 - 79,5	Triple	21,0	21,0	105	105	117,0	76,0	EBM810N10N	
NPT 4"	NPT 3"	75,0 - 79,5	Triple	21,0	21,0	115	115	128,0	76,0	EBM11N810N	
	NPT 4"K	75,0 - 85,0	Triple	21,0	21,0	105	115	128,0	76,0	EBM10N10N	
	NPT 4"	85,0 - 95,0	Triple	21,0	21,0	115	115	128,0	77,0	EBM11N11N	

* Only Ex e/ Ex tb execution.